

TECE
close to you

Design & Creation

**FREEDOM IN
DESIGN**





Understanding people and their requirements – that is what motivates

In this spirit, and with our customers in mind, we develop products and services that offer more room for creativity and convenience in terms of use.



02

03

Get to know us

TECE is an innovator in the sanitary installation sector. We make an impact with products that can be used to build an entire world. With well-thought-out solutions, reliable technology, long-lasting functions and timeless design.

We are a medium-sized, family-owned and run business with headquarters in Emsdetten (Germany). We have been developing products and services for fitters, planners and architects ever since the company was established in 1987. Today, with 22 international branches, we feel at home all over the world and maintain open communication with our partners in the full spirit of “Close to you”.



Sanitary systems

From toilet ceramics and flush plates to sanitary modules



Flush plates

Selected collections for private homes or public buildings, with different designs, materials and colours



Drainage systems

Shower channels, shower profiles and point drainage systems

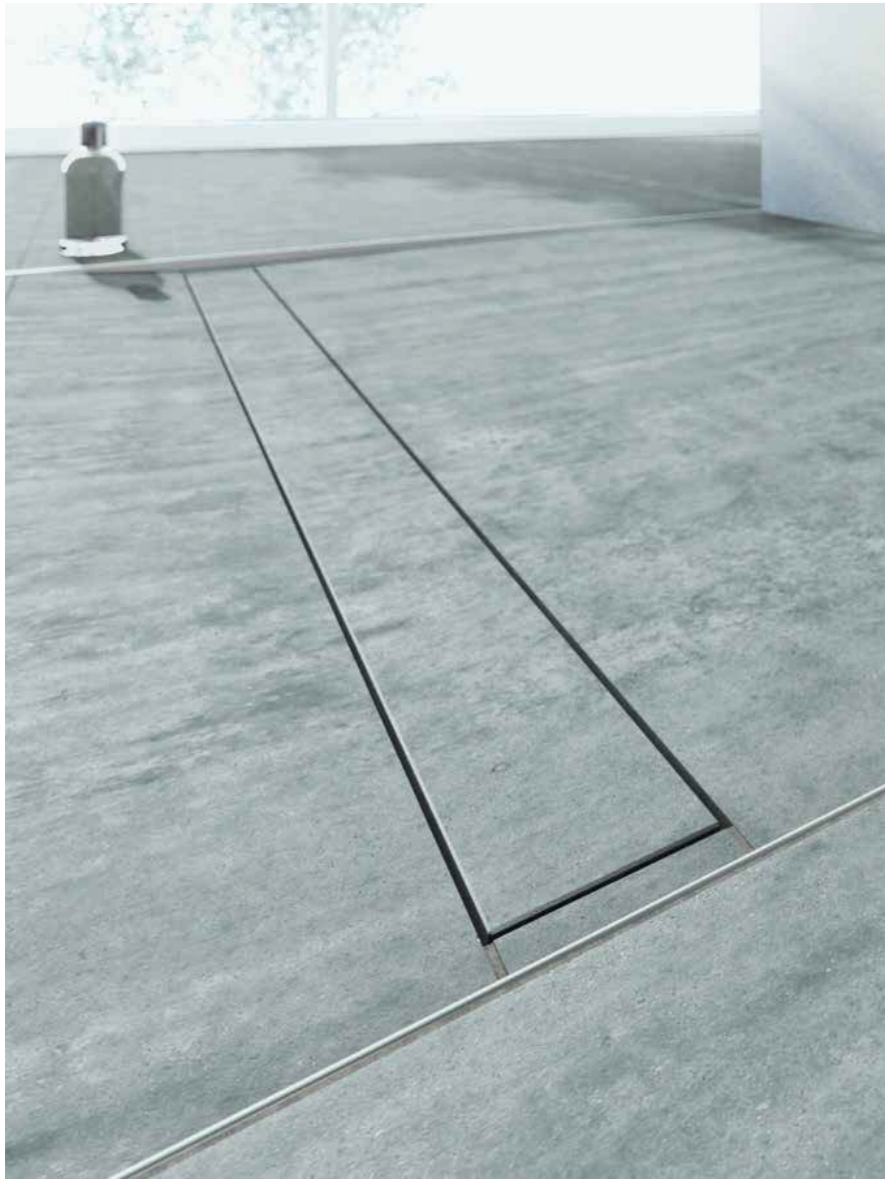

Shown Right:

TECESquare flush plate in black glass and brushed stainless steel with TECE 8cm in-wall cistern.

TECESquare glass can be installed level with the tiled surface with the use of the TECE recessed installation frame.

Shown Left:

TECEDrainline shower channels form the interface between architecture and housing technology:

They strip function and design right down to the essentials, freeing the bathroom from its limitations.

The result: a uniform, limitation-free floor and space design – for real living spaces.

Shown Below:

TECELux, and all inclusive toilet convenience.

The TECELux toilet terminal offers the perfect combination of timeless design and sophisticated technology.

The highlight: the latest technology is concealed in the pre-wall's inspection opening behind the glass plate.

The result: contact-free flush actuation, a night light, odour trap, insert chute for cleaning tablets and smooth height adjustment.





An excellent layout with an excellent design.

TECE products distinguish themselves through their clear contours and timeless design. Geometric shapes characterise the layout, while the focus remains on function. A variety of surfaces offer a wide range of means of expression.



Shown Above:

TECEdrainline shower channel made from stainless steel, shown with tile insert.

Shown Left:

TECEloop flush plate in white glass and polished chrome buttons with TECE 8cm in-wall cistern.

Also featured is the TECEsteel shower channel in polished stainless steel.

Shown Below:

TECEsquare flush plate in brushed stainless steel with TECE 8cm in-wall cistern.



Shown Above:

TECEnow flush plate in chrome with TECE 8cm in-wall cistern.

The TECEnow flush plate with dual-flush technology is highly convincing with its minimalist design. This model has also been tried and tested in price-sensitive projects and in public areas.





TECElux

Spotlight on the toilet terminal.

Press and flush was yesterday. The toilet of today can do so much more: rinse and blow dry, purify the air and flush automatically. But the aesthetics are often sacrificed for this additional hygiene and comfort. TECE has now created a form that unites all functions. The technology disappears into the wall and all that remains visible is a flat facing made of white safety glass.

This stylish new system can be combined with almost all toilet ceramics and most shower toilets.

TECElux is the terminal for all toilet functions of today - and tomorrow.

- Integrates new functions in the wall and can be incorporated into any bathroom ambience
- Electronic flush with approach sensor
- The panel with a large surface protects the wall from splashes and thus enables wall design without tiles
- Air filter system with ceramic odour filter
- Additional seat height adjustment

TEClux mini

Design meets technology.

Electronic functions

The sensor detects when a person is approaching the toilet, and only illuminates the flush buttons then. The flush actuation is touch-free or by simply touching the button area.

A programmable remote control allows you to individually adjust the recognition range, activation time or display brightness. This can also be used to set the intervals of individual functions such as the hygiene or safety flush.

- Electronic actuation, touch-free or by touching the button area
- Particularly hygienic due to the touchless flush
- High-quality, reduced design through smooth glass surfaces with flat structure
- Simple cleaning thanks to seamless, tough glass surfaces.
- Individual programming with remote control (optional)
- "Night light function" via approach sensor
- Illuminated button silhouette

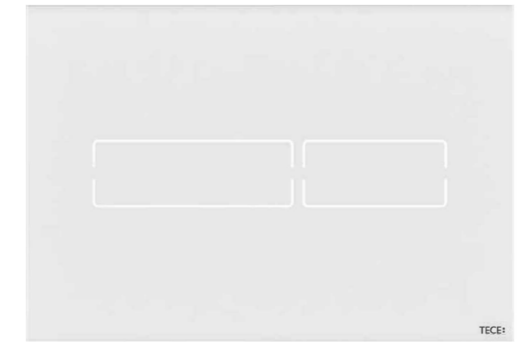

9.240.960



9.240.961



9.240.646



9.240.647



9.240.649

Codes	Plate Dimensions
White	9.240.960 (W x H x D) 220 x 150 x 11mm
Black	9.240.961

Codes - Recessed Frames

White Frame	9.240.646
Black Frame	9.240.647
Chrome Frame	9.240.649

Installation Information

- Suitable only for the following cisterns-
9.300.055 9.041.020
9.300.056 9.041.021
- For optional recessed installation 25mm wall cladding required prior to tiling

Design & technology

The toilet terminal TECElux hides the working parts behind the wall. An extremely flat glass facing closes the inspection opening and conceals the cistern, connections for water and power and, depending on the version, an odour extraction or height adjustment for the ceramics.

With its simple aesthetics, TECElux blends in with the architecture of any bathroom. The terminal's large glass surface consists of two parts that give the appearance of a single unit. The glass facing serves as a splash guard for the wall and means the wall does not have to be tiled. The toilet terminal can be combined with practically any ceramics and even with shower toilets.

Form & function

However, it is easily accessible even after installation thanks to the removable upper glass facing and the large inspection opening. Retrofitting, assembly and maintenance can therefore be carried out with little effort. The terminal with cistern forms the basis, and you choose the range of functions.

A TECElux toilet terminal always consists of:

- a TECElux toilet module
- an upper glass facing with actuation unit in white or black
- a lower glass facing with toilet attachment and notches for different power and water connections in white or black

Cistern Codes

9.600.403 TECElux 400 cistern

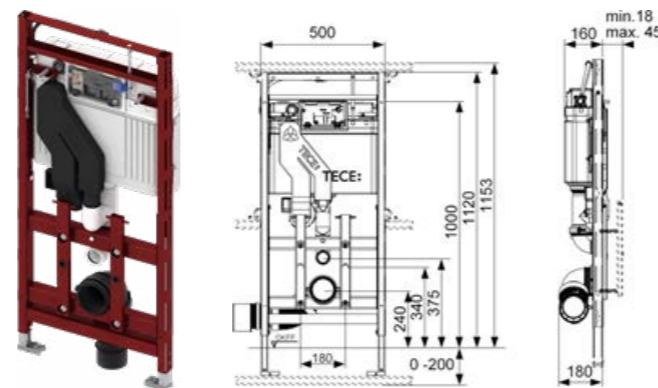

9.600.403

Glass Panels

- 9.650.002 White/Sen-Touch Top Glass
- 9.650.100 White Bottom Glass
- 9.650.003 Black/Sen-Touch Top Glass
- 9.650.105 Black Bottom Glass



9.650.002

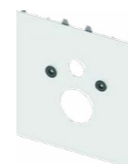

9.650.100

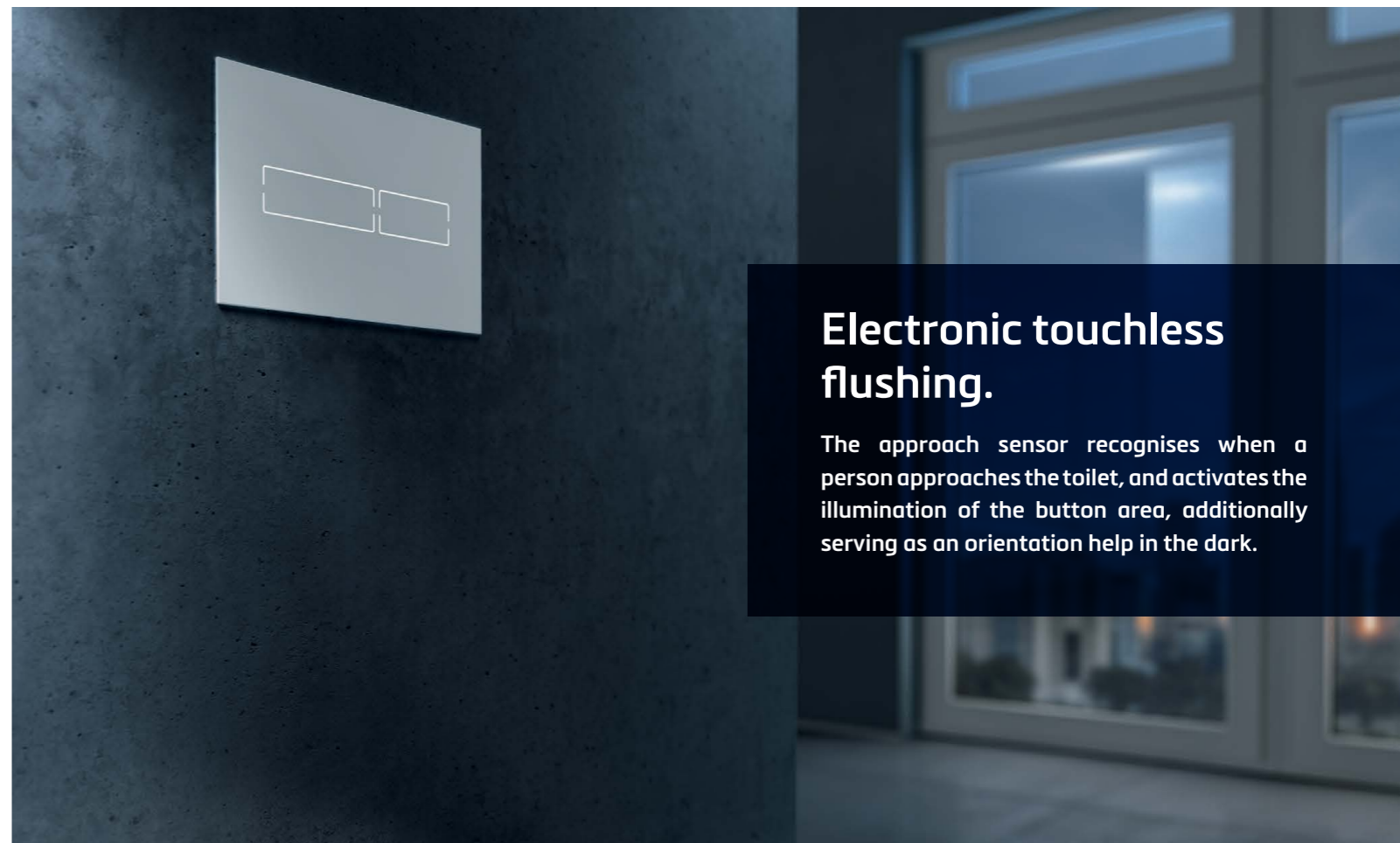

Electronic touchless flushing.

The approach sensor recognises when a person approaches the toilet, and activates the illumination of the button area, additionally serving as an orientation help in the dark.



TECE universal cistern 16cm

Saving water or flushing well?

Save water with dual-flush technology

With a simple slider, the fitter can choose between 4.5, 6, 7.5 and 9 litres for the full flush, while the reduced flush remains a constant 3 litres. This flexibility, in particular, means sustainability for TECE: The cistern's flush volume and flush flow rate can be adapted to any requirement.

With a TECE cistern, both are possible.

The flush pressure can be flexibly adapted to any toilet regardless of the ceramics used. With conventional drain valves, the flush pressure can only be subsequently curtailed, but not increased. By exchanging the throttle ring installed as standard, the flush pressure can be subsequently increased. If there is overspray, it can of course also be reduced.

Design & technology

Outlet valve

Sound insulation - copied from jet planes

Toilets without a flush rim are dominating the market due to their ease-of-cleaning and associated increase in hygiene. New designs and ceramic contours are always appearing. Accordingly, the demands on cisterns have also increased, as the rim design affects flushing and flush resistance. Consequently, sound effects or impact noises may occasionally be heard, emitted by the valve plate when the drain valve closes. For this reason, TECE has revised the time-tested drain valve with respect to sound insulation.

To optimise sound levels, it has applied a technical trick from the aviation industry. A chevron nozzle, similar to that of an aircraft turbine, has been fitted to optimise flow at the outlet. This ensures stable flow conditions and lower sound levels without slurping noises.

- Quality & reliability at an affordable price
- Proven TECE cistern with 10-litre safety tank
- Sound-tested

Cistern Codes - for wall hung pans

1120mm	9.300.055 - Wall hung	Front actuation only	WELS 4 Star 4.5/3
820mm	9.300.056 - Wall hung	Front or Top actuation	WELS 4 Star 4.5/3

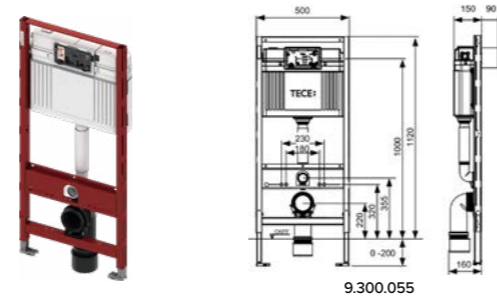

9.300.055

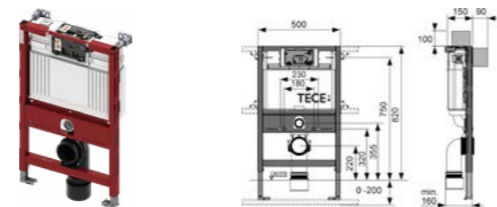

9.300.056

Cistern Codes - for pedestal pans

1120mm	9.041.021 - Pedestal	Front actuation only	WELS 4 Star 4.5/3
820mm	9.041.020 - Pedestal	Front or Top actuation	WELS 4 Star 4.5/3

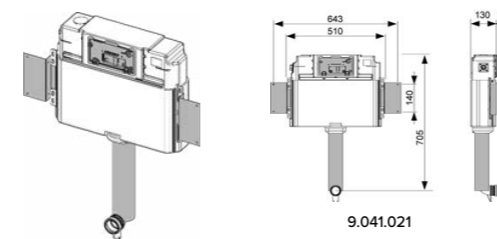

9.041.021

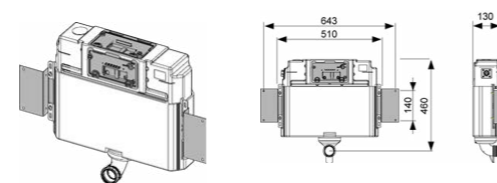

9.041.020

TECE 8cm cistern

A view inside.



The TECE8cm cisterns hold 9.5 litres of water and similar to the TECE cistern 16cm, the Design Plus award winning Outlet valve can be easily removed and the full flush adjusted to flush either 4.5, 6 or 9 litres.

When the valve is exchanged, no individual parts need to be taken apart or unscrewed, because the 8cm valve also forms a unit in which all parts are permanently attached to each other. The valve can then be easily removed from the cistern by bending and turning.

Cistern Codes - for wall hung pans

9.300.057 - Wall hung	Front actuation only	WELS 4 Star
-----------------------	----------------------	-------------

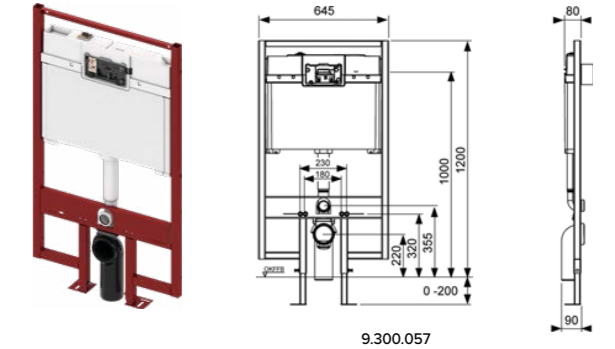

9.300.057

Cistern Codes - for pedestal pans

9.370.057 - Pedestal	Front actuation only	WELS 4 Star
----------------------	----------------------	-------------

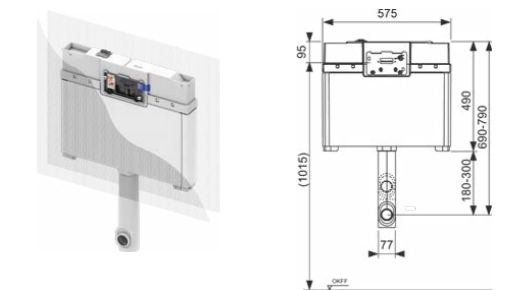

9.370.057

Installation Information

- 8cm cistern depth suitable for installation in 90mm stud walls, cavity wall or in front of a wall
- Suitable for all manual flush buttons (*TECElux mini not possible*)
- Wall covering minimum 18mm for standard flush button installation
- 25mm wall thickness required for recessed button installation
- 30mm wall thickness require when using TECEsquare Metal 2

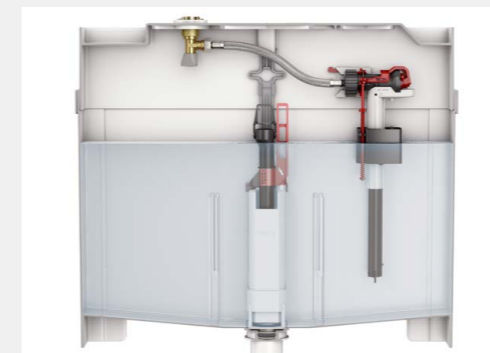

Fit for small spaces

TECE toilet module with 8 cm cistern to mount in metal or wooden post-and-beam walls or to mount in front of a solid wall construction. For toilet flush handle and TECE flush plates.



TECEsquare Metal 2

Extra-flat structure and simple installation.

The TECEsquare metal 2 emphasises the effect of the pure stainless steel and perfect integration in modern bathroom architecture with its extra-flat design. Three fine joints characterise both buttons for the flush – a wide button for the full flush and a small one for the partial flush.

The stainless steel surface with anti-fingerprint coating makes for a flawless appearance.

- Light and elegant thanks to the clearly structured surface
- Metal surface with extra-flat wall design
- Stainless steel surface with anti-fingerprint coating
- Toilet flush plate for dual-flush system
- Suitable for front or top actuation

Installation Information

- Minimum wall thickness 30mm (measured from front of cistern to finished front of wall)
- Suitable for all TECE cisterns

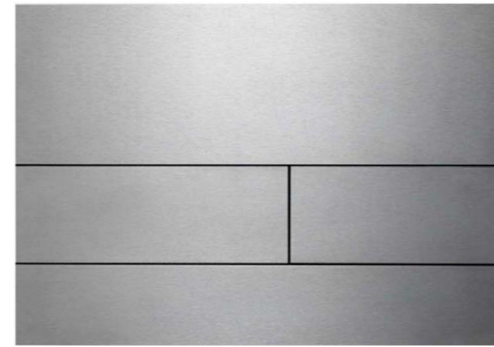

9.240.830



9.240.831



9.240.832



9.240.833

Codes	Plate Dimensions
Stainless Steel 9.240.830	(W x H x D) 220 x 150 x 3mm
Chrome 9.240.831	
Gloss White 9.240.832	
Matte Black 9.240.833	

TECEsquare Glass

Aesthetic in glass.

Thanks to their minimalistic design, the TECEsquare glass flush plates capitalise the aesthetic effect of the material. To complement the respective toilet flush plates there are matching fronts available made of white, green or black glass, which can be combined with different coloured push-buttons. The TECEsquare flush plates with glass surface can also be installed totally flush using the installation frame.

- Light and elegant thanks to the clearly structured surface
- Toilet flush plate for dual-flush system
- Suitable for front or top actuation
- Glass surface can be mounted flush with the toilet installation frames

Installation Information

- Suitable for all TECE cisterns
- For optional recessed installation 25mm wall cladding required prior to tiles
- Recessed installation frame must be installed prior to tiling

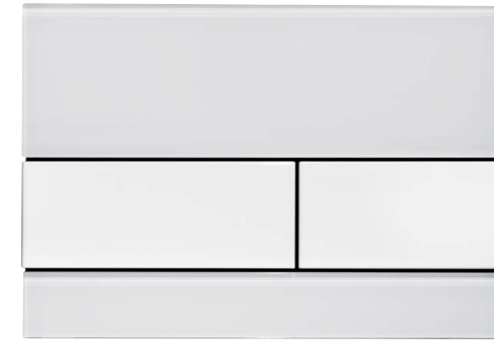

9.240.800



9.240.801



9.240.802



9.240.806



9.240.807



9.240.809



9.240.646



9.240.647



9.240.649

Codes	Plate Dimensions
White Frame 9.240.646	(W x H x D) 220 x 150 x 11mm
Black Frame 9.240.647	
Chrome Frame 9.240.649	

Codes - (Glass - Buttons)	Plate Dimensions
White-White 9.240.800	(W x H x D) 220 x 150 x 11mm
White-Stainless Steel 9.240.801	
White-Chrome 9.240.802	
Black-Stainless Steel 9.240.806	
Black-Chrome 9.240.807	
Black-Black 9.240.809	

TECEloop

Timeless clarity. Flush mounted- as if it were a part of the wall.

TECEloop flush plates with dual-flush system are reduced to a minimum in their formal appearance. The different material and colour combinations of frames, buttons and the unique option of flush-mounted installation lead to expanded design opportunities.

The option to flush-mount the glass flush plates is an outstanding TECEloop feature. Using the available installation set, assembly is as easy as it is precise.

- Glass surface can be mounted flush with the toilet installation frames
- Modular design with 104 combination options
- Flush-mounted installation and simple assembly
- Toilet flush plate for dual-flush system
- Suitable for front or top actuation
- Colour is tailored to products from renowned manufacturers

Installation Information

- Suitable for all TECE cisterns
- For optional recessed installation 25mm wall cladding required prior to tiling
- Recessed installation frame must be installed prior to tiling

Codes - (Glass - Buttons)	Plate Dimensions
White-White 9.240.650	(W x H x D) 216 x 145 x 6mm
Black-White 9.240.654	
Black-Matte Chrome 9.240.655	
Black-Chrome 9.240.656	
Black-Black 9.240.657	
White-Matte Chrome 9.240.659	
White-Chrome 9.240.660	

TECEloop ABS

When it comes to special hygiene.

The plastic TECEloop flush plates are the same size and shape as the TECEloop flush plates made of glass. The button actuation mechanism is also identical. The antibacterial version is particularly recommended for use in hospitals, old people's and nursing homes as well as in other facilities where hygiene is especially important. The silver particles contained in the material used to make the plate significantly reduce the amount germs multiply. No option is available to flush mount the plastic version.

Installation Information

- Suitable for all TECE cisterns

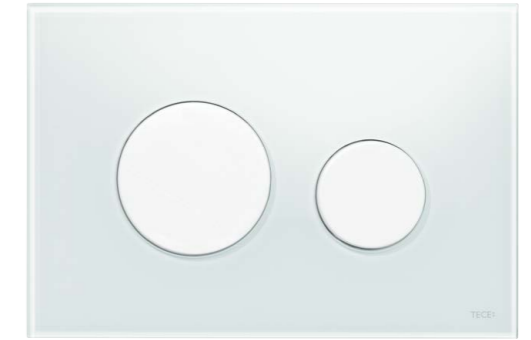

9.240.650



9.240.654



9.240.655



9.240.656



9.240.657



9.240.659



9.240.660



9.240.646



9.240.647



9.240.649

Codes - Recessed Frames	Plate Dimensions
White Frame 9.240.646	(W x H x D) 220 x 150 x 11mm
Black Frame 9.240.647	
Chrome Frame 9.240.649	

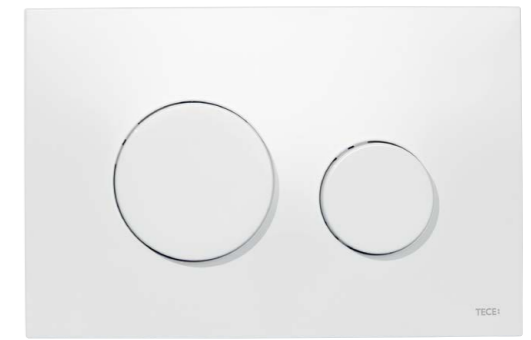

9.240.600



9.240.625



9.240.626



9.240.627

Codes	Plate Dimensions
Gloss White 9.240.600	(W x H x D) 216 x 145 x 6mm
Matte Chrome 9.240.625	
Chrome 9.240.626	
White-Chrome 9.240.627	

TECEplanus

For people that are sometimes a bit heavy handed with the buttons.

The TECEplanus flush plate made of stainless steel is robust and especially vandal-proof or ABS. A concealed screw further protects it against theft.

So, they are particularly suitable for public sanitary areas, restaurants or hotels. Their especially compact dimensions and elegant design harmonise with any mood.

- Robust flush plate with stainless steel surface
- Flush plate screws on covertly
- Suitable for front or top actuation
- Particularly suitable for public sanitary areas, restaurants or hotels
- Especially compact dimensions and elegant design



9.240.320



9.240.321



9.240.324



9.240.333



9.240.365



9.240.366

Codes	Plate Dimensions
Stainless Steel 9.240.320	(W x H x D) 214 x 144 x 15mm
Chrome 9.240.321	
Gloss White 9.240.324	
Matte Black ABS 9.240.333	
Antique Copper 9.240.365	
Old Brass 9.240.366	

Installation Information

- Suitable for all TECE cisterns
- Surface installation only
- Minimum wall depth 18mm (includes sheeting and Tiles)

TECEnow

Good design doesn't have to be expensive.

With a flat structure and minimalist design, the new flush plate proves that good design doesn't have to be expensive. Flush mounting is also possible, thanks to the familiar TECE installation frame and the special spacing frame. TECEnow offers the tried-and-trusted dual-flush technology with small and large volume flushing.

- Very flat plastic flush plate
- Clear rectangular design
- Proven dual-flush system
- Suitable for front or top actuation

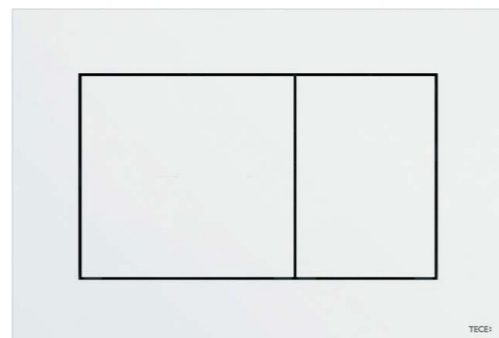

9.240.400

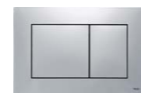

9.240.401



9.240.402



9.240.403



9.240.404

Installation Information

- Suitable for all TECE cisterns
- Surface installation only
- Minimum wall depth 18mm (includes sheeting and Tiles)

Codes	Dimensions
Gloss White 9.240.400	(W x H x D) 220 x 150 x 5mm
Chrome 9.240.401	
Matte Chrome 9.240.402	
Gloss Black 9.240.403	
Matte Black 9.240.404	

Shower Channels



TECEdrainline

Almost invisible.

Our drainage systems can be perfectly integrated into modern designed bathrooms. TECEdrainline shower channels free the bathroom from disturbing separations such as the shower trays and cubicles and allow a uniform floor design.

Thanks to the "plate" tileable channel, the shower channel can be perfectly fitted into the flooring. The solid construction of the TECEdrainline shower channel enables especially small drainage slots. The tileable channel is also available for the angled channel in various sizes.

TECEdrainline produces accessible bathrooms with a focus on real space for living.

- Easy to clean
- Center outlet
- Tapered base
- Tile insert
- Push fit connection
- Made in Germany

Installation Information

All TECEdrainlines have a center outlet and push fit into 80mm floor waste.

TECEdrainline with an exceptional low profile installs easily into the tile screed or tile cement. With 1 edge of the tiling flange perforated the edge can easily be bent up 90°, so the wall tile sits directly onto the tile flange allowing for an extremely close installation against the wall.

The visible part of the TECEdrainline is the overall length minus 61mm.



Codes		
700mm	Stainless Steel Drain with Tile Insert	630700-600770
800mm	Stainless Steel Drain with Tile Insert	630800-600870
900mm	Stainless Steel Drain with Tile Insert	630900-600970
1000mm	Stainless Steel Drain with Tile Insert	631000-601070
1200mm	Stainless Steel Drain with Tile Insert	631200-601270
1500mm	Stainless Steel Drain with Tile Insert	631500-601570

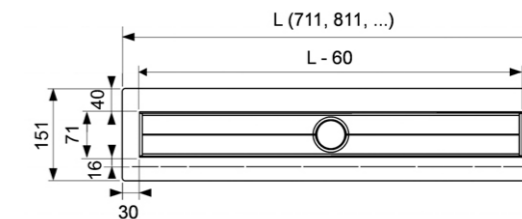



Showroom, Selection & Training Centre

Unit 2, 37 Howe St, Osborne Park WA 6017

Phone . 08 9446 3288

Email . info@groagencies.com.au

www.groagencies.com.au